

PRICE LIST

**“ALFA WOOD BULGARIA”S.A.
WOOD PROCESSING COMPANY**

9120 Dolni Chiflik, Varna
Sales Department - tel: 052 / 685 809; fax: 052-685 815
E-mail: sales@alfawood.bg



14.01.2009



CONTENTS

<u>VENEERED MDF</u>	1
<u>VENEERED MDF 4mm & 7mm (DOOR SKINS)</u>	4
<u>VENEERED CHIPBOARD</u>	5
<u>RAW CHIPBOARD</u>	6
<u>LACQUERED HDF</u>	7
<u>M.F.C. & M.F.MDF</u>	8
<u>RAW MDF</u>	9
<u>DOOR SKINS</u>	10
<u>PROFILES No2, No8 & No12</u>	11
<u>PROFILES No10, No11 & No23</u>	12
<u>PROFILES No9, No27, No48 & No48 WITH CROOVE</u>	13
<u>PROFILES No24, No25 & No26</u>	14
<u>PROFILES No71, No17</u>	15
<u>CURVED DOOR FRAMES MDF & PROFIL No63</u>	16
<u>CURVED DOOR FRAMES SOLID WOOD</u>	17
<u>CURVED DOOR FRAMES PLYWOOD</u>	18
<u>DOOR FRAMES MDF & PROFIL No62</u>	19
<u>DOOR FRAMES SOLID WOOD</u>	20
<u>DOOR FRAMES PLYWOOD</u>	21
<u>EDGE BANDINGS</u>	22
<u>SOFT FORMING & POST FORMING C.P.L.</u>	23
<u>KITCHEN WORKTOPS</u>	24
<u>VENEER</u>	25

VENEER	THICKNESS MM	EURO / SQ.M.		
		EXTRA	A/PANEL	B/PANEL
ANEGRE	9	14.13	11.80	10.13
	11	15.21	12.62	11.15
	13	15.78	13.20	11.80
	17	17.49	13.96	12.60
	20	18.96	15.84	14.55
	23	20.18	17.29	16.15
	26	21.71	18.39	17.30
	31	24.13	20.63	19.25
ANEGRE QUARTERS	9	14.57	-	-
	11	15.21	-	-
	13	16.22	-	-
	17	17.93	13.95	-
	20	19.39	-	-
	23	20.61	-	-
	26	22.17	-	-
	31	24.57	-	-
OAK (DOS) ASH	9	18.93	15.51	13.96
	11	20.04	16.55	-
	13	21.22	17.65	-
	17	22.12	18.39	16.46
	20	23.65	19.88	18.44
	23	25.04	21.22	19.82
	26	26.66	22.62	21.27
	31	29.15	24.86	23.57
OAK QUARTERS	9	21.17	19.06	-
	11	22.22	19.88	-
	13	23.56	21.08	-
	17	24.43	22.01	20.75
	20	25.99	23.56	-
	23	27.55	25.13	-
	26	28.96	26.63	-
	31	31.67	29.18	-
KOTO	9	12.84	11.08	-
	11	13.91	12.00	-
	13	14.98	13.07	-
	17	15.89	14.07	-
	20	17.11	15.27	-
	23	18.46	16.62	-
	26	19.80	17.89	-
	31	22.01	20.17	-
LIMBA	9	13.50	11.65	-
	11	14.62	12.64	-
	13	15.69	13.71	-
	17	16.68	14.70	-
	20	17.97	16.05	-
	23	19.40	17.40	-
	26	20.81	18.82	-
	31	23.13	21.22	-
CHERRY	9	28.47	20.97	-
	11	29.69	22.04	-
	13	30.95	23.31	-
	17	31.89	24.12	-
	20	33.44	25.63	-
	23	35.02	27.11	-
	26	36.58	28.64	-
	31	39.19	31.13	-

* The prices are without VAT.

VENEER	THICKNESS MM	EURO / SQ.M.		
		EXTRA	A/PANEL	B/PANEL
BEECH	9	17.24	12.15	10.60
	11	18.30	12.91	11.35
	13	19.49	13.66	12.10
	17	20.27	14.59	13.02
	20	21.96	15.80	14.24
	23	23.43	17.98	16.44
	26	25.05	19.63	18.09
	31	27.59	22.76	21.19
AFRICAN WALNUT	9	17.68	15.89	-
	11	18.82	17.05	-
	13	20.10	18.23	-
	17	20.81	19.03	-
	20	22.65	20.81	-
	23	24.13	22.31	-
	26	25.70	23.86	-
	31	28.34	26.48	-
PINE	9	17.46	15.89	-
	11	18.60	17.11	-
	13	19.88	18.32	-
	17	20.81	19.30	-
	20	22.44	21.01	-
	23	24.08	22.65	-
	26	25.70	24.20	-
	31	28.34	26.98	-
OREGON	9	24.20	21.22	-
	11	25.13	22.14	-
	13	26.21	23.21	-
	17	27.70	24.70	-
	20	29.04	25.99	-
	23	30.32	27.41	-
	26	31.67	28.69	-
	31	34.03	31.12	-
BUBINGA	9	21.58	-	-
	11	22.86	-	-
	13	24.00	-	-
	17	24.99	-	-
	20	26.48	-	-
	23	28.11	-	-
	26	29.69	-	-
	31	32.30	-	-
AMERICAN WALNUT	9	24.20	21.22	-
	11	25.13	22.14	-
	13	26.21	23.21	-
	17	27.70	24.70	-
	20	29.04	25.99	-
	23	30.32	27.41	-
	26	31.67	28.69	-
	31	34.03	31.12	-
MAHAGON	9	12.84	10.79	-
	11	13.63	11.65	-
	13	14.55	12.57	-
	17	15.84	13.84	-
	20	16.98	15.05	-
	23	18.82	16.98	-
	26	20.01	18.40	-
	31	22.08	20.23	-

* The prices are without VAT.



**PANEL
DIMENSIONS**

**MM
2200X1850**

VENEERED MDF

VENEER	THICKNESS MM	EURO / SQ.M.		
		EXTRA	A/PANEL	B/PANEL
MDF 17 MM.				
ANEGRE	17	16.98	12.84	-
BEECH	17	18.23	13.21	-
OAK (DOS)	17	22.58	17.23	-
OAK (QUARTERS)	17	24.43	19.39	-
ASH	17	-	17.23	-
LIMBA	17	-	13.13	-
CHERRY	17	-	22.92	-

* ЦЕНИТЕ СА БЕЗ ДДС.



**PANEL
DIMENSIONS**

**MM
2200X1850**

VENEERED MDF

VENEER	THICKNESS MM	EURO / SQ.M.		
		EXTRA	A/PANEL	B/PANEL
MDF 4 MM.				
ANEGRE	4	11.36	8.62	7.63
ANEGRE	5	11.82	9.29	8.04
OAK QUARTERED BUBINGA AFRICAN WALNUT	4	15.07	11.25	10.08
OAK DOS, ASH	4	13.27	10.96	9.81
PEAR, AFRICAN WALNUT	4	20.78	13.24	-
CHERRY	4	21.41	14.17	12.30
KOTO, LIMBA, MAHOGANY	4	10.36	8.04	-
PINE	4	12.16	9.95	8.95
BEECH	4	12.06	9.15	8.75

MDF 7 MM. (DOOR SKINS)				
ANIEGRE	7	12.60	9.94	8.54
OAK (QUARTERED)	7	16.48	12.59	11.52
OAK(DOS), ASH	7	15.00	11.92	10.83
CHERRY PEAR, AMERICAN WALNUT	7	23.35	18.74	-
KOTO. LIMBA, MAHOGANY	7	11.85	9.45	-
PINE	7	13.64	11.37	-
BEECH	7	11.86	9.98	9.58
OREGON BUBINGA, AFRICAN WALNUT	7	17.59	-	-

* The prices are without VAT



**PANEL
DIMENSIONS**

MM
3050X1850
3050X1220

**VENEERED
CHIPBOARD**

VENEER	THICKNESS MM	EURO /SQ.M.		
		EXTRA	A/PANEL	B/PANEL
ANEGRE	9	12.19	9.65	-
	11	12.33	9.78	-
	13	12.96	10.38	-
	17	13.21	10.68	8.81
	19	13.77	11.18	9.28
	23	15.02	12.40	-
ANEGRE 2440X1830 1830X1220	17	-	9.91	8.21
	19	-	-	8.64
OAK DOS ASH	9	16.85	14.04	-
	11	17.08	14.31	-
	13	17.56	14.77	-
	17	17.93	15.40	13.90
	19	18.43	15.85	14.73
	23	19.64	16.68	-
OAK QUARTERS	9	18.63	16.02	-
	11	18.86	16.28	-
	13	19.37	16.68	-
	17	19.79	17.11	15.59
	19	20.21	17.58	-
	23	21.44	18.73	-
KOTO LIMBA MAHAGON	9	10.68	9.32	-
	11	10.89	9.39	-
	13	11.33	9.45	-
	17	11.69	9.62	-
	19	12.12	10.25	-
	23	13.19	11.90	-
BEECH	9	14.84	11.66	-
	11	15.07	11.86	-
	13	15.55	12.30	-
	17	15.99	12.20	10.72
	19	16.42	12.62	11.25
	23	17.78	14.27	-
BEECH 2440X1830 1830X1220	17	-	11.58	10.18
	19	-	-	10.69
PINE AFRICAN WALNUT	9	14.84	13.26	-
	11	15.07	13.56	-
	13	15.55	13.98	-
	17	15.99	14.40	-
	19	16.42	14.91	-
	23	17.78	16.28	-
CHERRY PEAR	9	22.88	17.16	-
	11	23.01	17.38	-
	13	23.51	17.89	-
	17	23.88	18.27	-
	19	24.37	18.79	-
	23	25.66	20.04	-
AMERICAN WALNUT OREGON	9	19.27	17.56	-
	11	19.57	17.78	-
	13	20.00	18.27	-
	17	20.43	18.63	-
	19	20.87	19.21	-
	23	22.14	20.43	-

*The prices are without VAT



RAW CHIPBOARD

THICKNESS MM	EURO/CUB.M		
	3660 X 1830	2440 X 1830 2440 X 1220	3660 X 600
15	200	195	190
16	200	195	190
18	200	195	190
22 - 28	212	207	202

* ЦЕНИТЕ СА БЕЗ ДДС.



LACQUERED HDF

HDF		
THICKNESS MM	EURO/SQ.M.	
	WHITE	COLOR
2750X1850MM		
2.5	1.74	1.94
3	1.84	2.05

* ЦЕНИТЕ СА БЕЗ ДДС.



MELAMINED CHIPBOARD and MDF

MELAMINED CHIPBOARD 2440X1830 MM				
THICKNESS MM	EURO/SQ.M.			
	WHITE 80gr	WHITE 110gr	COMMERCIAL	EXCLUSIVE
8	3.42	3.59	3.90	4.22
12	4.07	-	-	4.81
16	4.62	4.78	5.10	5.41
18	4.98	5.14	5.47	5.77
25	6.56	6.72	7.04	7.34

***Legend:**

commercial line : 601, 202, 702, 218, 318, 127, 134, 324, 424

exclusive line : 052,055,151,083,153,094, 088, 060, 402, 057, 802, 201, 033

MELAMINED MDF (TWO SIDES)		
3660X1850MM EURO/SQ.M		
THICKNESS MM	WHITE 80gr	COLOR
8	6.40	7.69
10	7.02	8.07
12	7.77	9.18
16	8.35	10.51
19	9.92	12.48
22	11.49	14.45
25	12.84	15.38

MELAMINED MDF (ONE SIDES)		
3660X1830MM EURO/SQ.M.		
THICKNESS MM	WHITE 80gr	COLOR
8	6.33	6.83
10	6.53	7.03
12	7.46	7.97
16	7.84	9.64
19	9.32	11.45

* The prices are without VAT



RAW MDF

THICKNESS MM	MDF "ALFA WOOD PINDOS" 2200X1850, 2800x2200 MM, 3050x1220MM, 3050x1850MM, 3660x1850MM, 2300x1220MM			
	EURO/CUB.M.		EURO/SQ.M.	
3	537		1.61	
4	524		2.10	
6	481		2.89	
7	481		3.37	
8	440		3.52	
10	440		4.40	
12	419		5.03	
	3050x1220, 2440x1220, 2300x1220, 2050x1220, 1850x1220 MM		3660x1850, 3050x1850,2800x1850, 2440x1850, 2200x1850, 2800x2200 MM	
	EURO/CUB.M.	EURO/KB.M.	EURO/CUB.M.	EURO/SQ.M.
16	386	6.18	406	6.50
19	386	7.33	406	7.72
22	386	8.49	406	8.94
25	400	10.01	419	10.48
30	400	12.01	419	12.58
38	422	16.03	-	-
45	445	20.02	-	-

*The prices are without VAT



DOOR SKINS MDF

MODEL (BY OUR CATALOG)	VENEER	EURO / 1 PCS	
		2200X65 220X070 2200X75 220X080 2200X85 220X090 2200X95	2200X100 2200X105
DOOR SKINS MODEL "A"	RAW	8.36	9.98
	ANIEGRE	24.68	28.06
	OAK	28.06	31.44
	ASH	28.06	31.44
	PINE	28.06	31.44
	BEECH	28.06	31.44
	CHERRY	40.58	44.34
	BUBINGA	40.58	44.34
	WALNUT	40.58	44.34
DOOR SKINS MODEL "B"	RAW	10.25	11.81
	ANIEGRE	28.06	31.44
	OAK	31.44	34.61
	ASH	31.44	34.61
	PINE	31.44	34.61
	BEECH	31.44	34.61
	CHERRY	44.34	48.06
	BUBINGA	44.34	48.06
	WALNUT	44.34	48.06
<u>GLASS PANEL</u> DOOR SKINS MODEL "T"	RAW	8.36	9.98
	ANIEGRE	24.68	28.06
	OAK	28.06	31.44
	ASH	28.06	31.44
	PINE	28.06	31.44
	BEECH	28.06	31.44
	CHERRY	40.58	44.34
	BUBINGA	40.58	44.34
	WALNUT	40.58	44.34

* The prices are without VAT

PROFILES
MDF

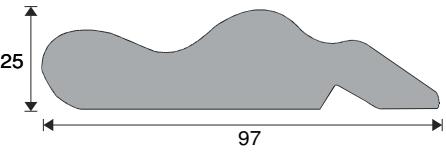
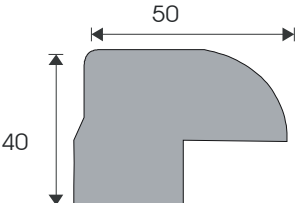
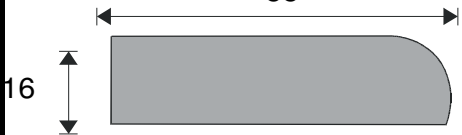
PROFILE NUMBER	VENEER	EURO /L.M.
<p>No 2</p> 	RAW	1.97
	ANIEGRE	2.88
	OAK	2.95
	ASH	2.95
	BEECH	2.95
	CHERRY	3.66
	BUBINGA	3.66
<p>No 8</p> 	RAW	1.37
	ANIEGRE	2.10
	OAK	2.10
	ASH	2.10
	BEECH	2.10
	CHERRY	2.62
	BUBINGA	2.62
FOIL	2.03	
<p>No 12</p> 	RAW	0.98
	ANIEGRE	1.37
	OAK	1.44
	ASH	1.44
	BEECH	1.44
	CHERRY	1.89
FOIL	1.37	

* The prices are without VAT

PROFILES

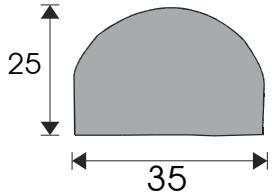
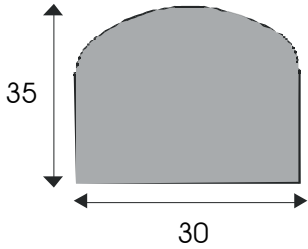
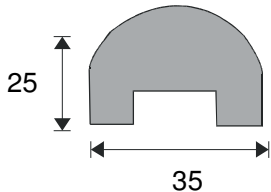
PROFILE NUMBER	VENEER	EURO/L.M.
<p>No 10</p> 	RAW	0.85
	ANIEGRE	1.31
	OAK	1.37
	ASH	1.37
	BEECH	1.37
	CHERRY	1.70
<p>No 11</p> 	RAW	0.91
	ANIEGRE	1.37
	OAK	1.44
	ASH	1.44
	BEECH	1.44
	CHERRY	1.77
<p>No 23</p> 	RAW	0.85
	ANIEGRE	1.31
	OAK	1.37
	ASH	1.37
	BEECH	1.37

* The prices are without VAT

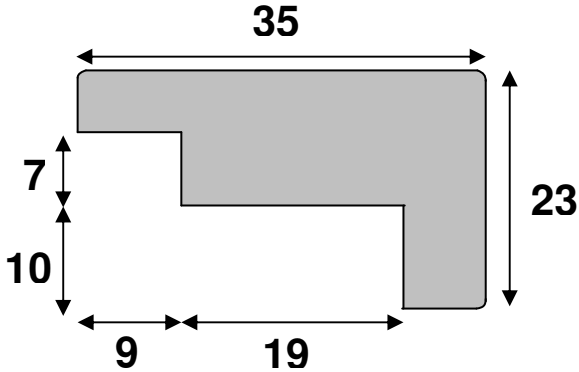
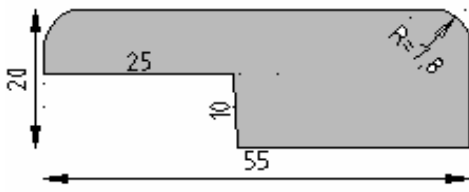
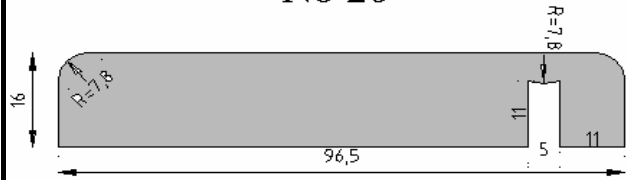
PROFILE NUMBER	VENEER	EURO/L.M.
<p>No 24</p> 	RAW	1.14
	ANIEGRE	1.65
	OAK	1.65
	ASH	-
	BEECH	1.65
	CHERRY	2.17
<p>No 25</p> 	RAW	1.18
	ANIEGRE	1.77
	OAK	1.83
	ASH	1.83
	BEECH	1.83
	CHERRY	2.42
<p>No 26</p> 	RAW	1.37
	ANIEGRE	2.10
	OAK	2.10
	ASH	2.10
	BEECH	2.10
	CHERRY	2.81

PROFILES

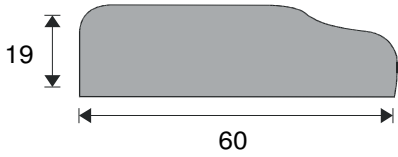
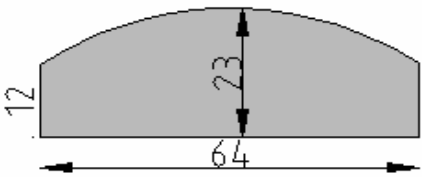
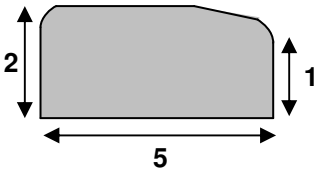
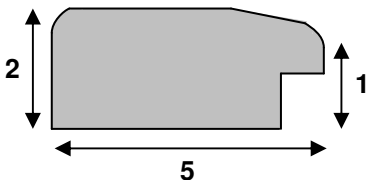
PROFILE NUMBER	VENEER	EURO/L.M.
<p>No 9</p> 	RAW	1.50
	ANIEGRE	2.49
	OAK	2.55
	ASH	2.55
	BEECH	2.55
	CHERRY	3.41
<p>No 27</p> 	RAW	1.54
	ANIEGRE	2.49
	OAK	2.55
	ASH	-
	BEECH	2.55
	CHERRY	3.41
<p>No 48</p> 	RAW	-
	ANIEGRE	2.03
	OAK	-
	ASH	-
	BEECH	2.03
	CHERRY	-
<p>No 48 WITH CROOVE</p> 	RAW	-
	ANIEGRE	2.03
	OAK	-
	ASH	-
	BEECH	2.03
	CHERRY	-

*The prices are without VAT

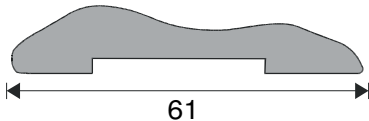
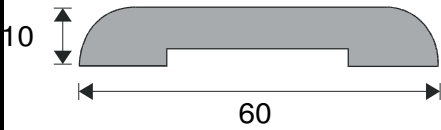
PROFILE NUMBER	VENEER	EURO/ L.M.
<p>No 17</p> 	RAW	0.79
	ANIEGRE	1.18
	OAK	1.18
	ASH	1.18
	BEECH	1.18
	CHERRY	1.58
<p>No 71</p> 	RAW	0.79
	ANIEGRE	1.18
	OAK	1.18
	ASH	1.18
	BEECH	1.18
PROFILE N71 PLYWOOD	OAK	1.40

* The prices are without VAT

CURVED DOOR FRAMES MDF & PROFIL 63

FRAME WIDTH	VENEER	EURO/L.M.
FRAME 13 cm	RAW	5.00
	ANIEGRE	7.05
	OAK	7.51
	BEECH	7.51
	ASH	7.51
	CHERRY	9.16
FRAME 15 cm	RAW	5.95
	ANIEGRE	8.38
	OAK	8.93
	BEECH	8.93
	ASH	8.93
	CHERRY	10.86
FRAME 18 cm	RAW	7.13
	ANIEGRE	10.05
	OAK	10.71
	BEECH	10.71
	ASH	10.71
	CHERRY	13.06
FRAME 24 cm	RAW	9.50
	ANIEGRE	13.43
	OAK	14.33
	BEECH	14.33
	ASH	14.33
	CHERRY	17.42
PROFIL No 63 MDF	RAW	1.20
	ANIEGRE	2.02
	OAK	2.11
	BEECH	2.11
	ASH	2.11
	CHERRY	2.50
PROFIL No 63 PLYWOOD	ANIEGRE	2.34
	OAK	2.49
	BEECH	2.49
	CHERRY	2.82

120/150/180/241

DOOR FRAME

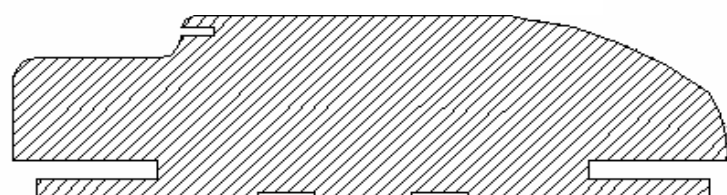

130/150/180/240

PROFIL No: 63

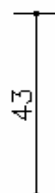
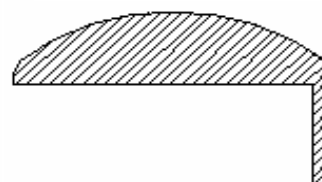

CURVED DOOR FRAMES SOLID WOOD

VENEERED		
FRAME WIDTH	VENEER	EURO / L.M.
FRAME 13cm	ANIEGRE	9.40
	OAK	10.01
	ASH	10.01
	BEECH	10.01
	CHERRY	12.22
FRAME 15cm	ANIEGRE	11.13
	OAK	11.91
	ASH	11.91
	BEECH	11.91
	CHERRY	14.49
FRAME 18cm	ANIEGRE	13.39
	OAK	14.27
	ASH	14.27
	BEECH	14.27
	CHERRY	17.43
FRAME 24cm	ANIEGRE	17.92
	OAK	19.12
	ASH	19.12
	BEECH	19.12
	CHERRY	23.22

CURVED FRAME

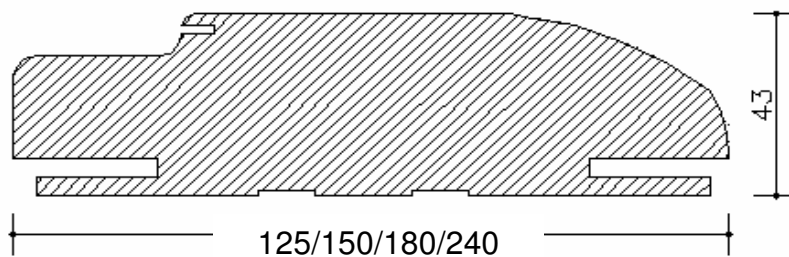

* The prices are without VAT

CURVED DOOR FRAMES PLYWOOD

VENEERED		
FRAME WIDTH	VENEER	EURO/ L.M.
FRAME 13cm	ANIEGRE	7.45
	OAK	7.95
	ASH	-
	BEECH	7.95
	CHERRY	9.79
FRAME 15cm	ANIEGRE	8.85
	OAK	9.46
	ASH	-
	BEECH	9.45
	CHERRY	-
FRAME 18cm	ANIEGRE	10.62
	OAK	11.33
	ASH	-
	BEECH	11.34
	CHERRY	-
FRAME 24cm	ANIEGRE	14.93
	OAK	15.93
	ASH	-
	BEECH	15.93
	CHERRY	-

CURVED FRAME

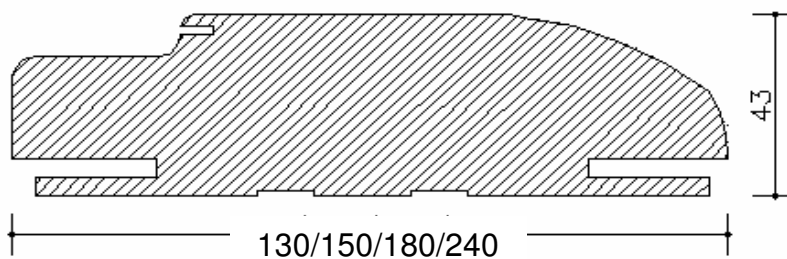

* The prices are without VAT

FRAME WIDTH	VENEER	EURO/L.M.
FRAME 13 cm	RAW	4.62
	ANIEGRE	6.00
	OAK	6.63
	BEECH	6.63
	ASH	6.63
	CHERRY	7.92
FRAME 15 cm	RAW	5.49
	ANIEGRE	7.36
	OAK	7.91
	BEECH	7.91
	ASH	7.91
	CHERRY	9.41
FRAME 18 cm	RAW	6.59
	ANIEGRE	8.84
	OAK	9.49
	BEECH	9.49
	ASH	9.49
	CHERRY	11.30
FRAME 24 cm	RAW	8.77
	ANIEGRE	11.92
	OAK	12.64
	BEECH	12.64
	ASH	12.64
	CHERRY	15.09
PROFIL No 62 MDF LENGTH 2.28m	RAW	1.00
	ANIEGRE	1.82
	OAK	1.86
	BEECH	1.86
	ASH	1.86
	CHERRY	2.39
PROFIL No 62 PLYWOOD LENGTH 2.28 m	ANIEGRE	2.02
	BEECH	2.12
	OAK	2.12
	CHERRY	2.58

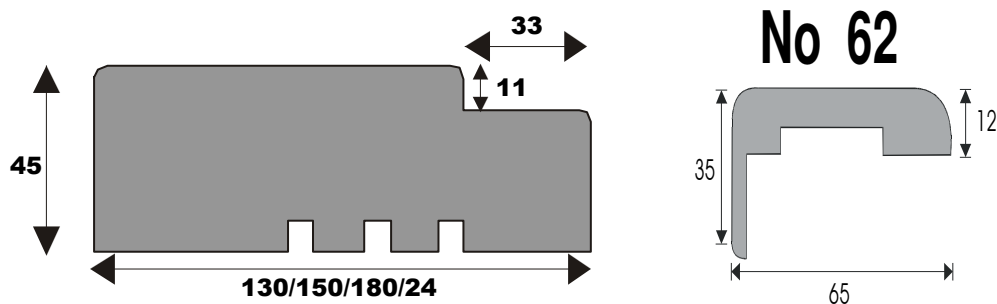

DOOR FRAMES SOLID WOOD

FRAME WIDTH	VENEER	EURO/ L.M.
FRAME 13cm	ANIEGRE	8.00
	OAK	8.83
	ASH	8.83
	BEECH	8.83
	CHERRY	10.57
FRAME 15cm	ANIEGRE	9.82
	OAK	10.55
	ASH	10.55
	BEECH	10.55
	CHERRY	12.55
FRAME 18cm	ANIEGRE	11.78
	OAK	12.65
	ASH	12.65
	BEECH	12.65
	CHERRY	15.06
FRAME 24cm	ANIEGRE	15.90
	OAK	16.86
	ASH	16.86
	BEECH	16.86
	CHERRY	20.12

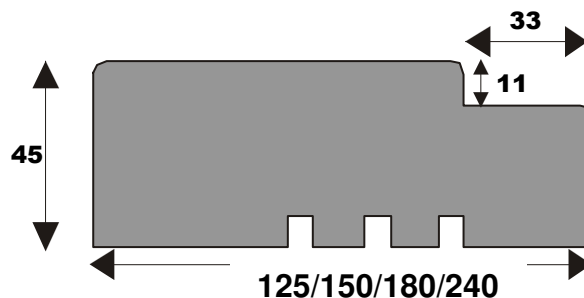

* The prices are without VAT



DOOR FRAMES PLYWOOD

FRAME WIDTH	VENEER	EURO/L.M.
FRAME 13cm	ANIEGRE	7.26
	OAK	7.74
	BEECH	7.74
	CHERRY	9.51
FRAME 15cm	ANIEGRE	8.61
	BEECH	9.22
FRAME 18cm	ANIEGRE	10.35
	BEECH	11.05
FRAME 24cm	ANIEGRE	14.54
	BEECH	15.52

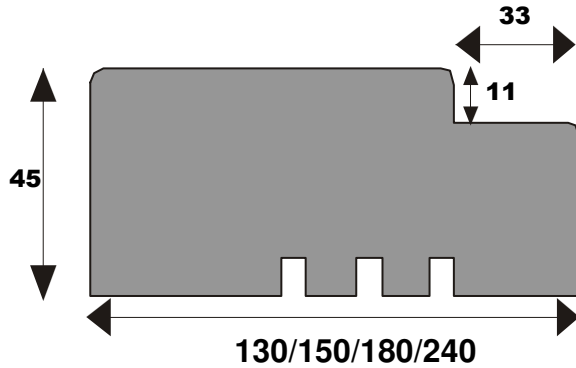

* The prices are without VAT



EDGE BANDINGS

EDGE BANDINGS WITH GLUE							
VENEERED						MELAMINE	
WIDTH MM.	ANIEGRE LIMBA MAHOGANY	OAK ASH PINE	BEECH OREGON WALNUT	KOTO	CHERRY BUBINGA	COLORED	WHITE
18	0.079	-	-	-	-	-	-
20	0.093	0.119	0.131	0.079	0.171	0.086	0.061
22	0.105	0.131	0.158	0.093	0.198	0.097	0.073
25	0.119	0.158	0.171	0.105	0.224	0.122	0.086
30	0.131	0.184	0.198	0.119	0.276	0.134	0.097
35	0.158	0.224	0.236	0.145	0.329	0.158	0.109
40	0.171	0.236	0.276	0.159	0.368	0.194	0.122
50	0.224	0.303	0.341	0.198	0.460	0.242	0.145

EDGE BANDINGS WITHOUT GLUE							
20	0.079	0.105	0.119	0.066	0.171	0.086	0.048
22	0.093	0.119	0.131	0.079	0.184	0.097	0.061
25	0.105	0.131	0.145	0.093	0.210	0.109	0.073
30	0.119	0.158	0.184	0.105	0.250	0.122	0.086
35	0.131	0.184	0.210	0.119	0.303	0.145	0.097
40	0.145	0.210	0.236	0.131	0.341	0.170	0.108
50	0.184	0.276	0.303	0.171	0.434	0.219	0.122

EDGE BANDINGS PVC "REHAU"						
0.45mm				3mm		
WIDTH MM.	MONOCHROM	WHITE	COLORED	MONOCHROM	WHITE	COLORED
19	0.087	0.075	-	0.435	0.435	-
22	0.099	0.075	0.162	0.509	0.509	0.621
28	-	-	0.236	0.708	0.708	0.857
33	-	-	-	0.857	0.857	1.131

*The prices are without VAT



SOFT FORMING & POST FORMING

SOFT FORMING

THICKNESS 18MM		
LENDTH MM	WIDTH MM	EURO/L.M.
3660	300	5.21
3660	350	5.94
3660	400	6.56
3660	450	7.43
3660	500	8.03
3660	550	8.79
3660	600	9.49

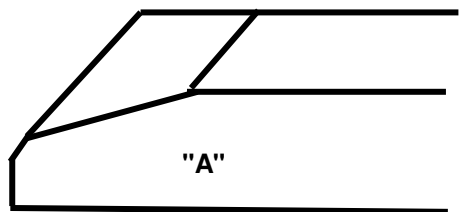
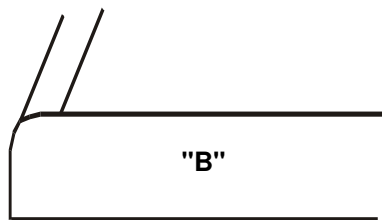

POST FORMING C.P.L.

THICKNESS 18MM		
LENDTH MM	WIDTH MM	EURO/L.M.
3660	300	7.00
3660	350	8.97
3660	400	9.33
3660	450	10.39
3660	500	10.66
3660	550	13.02
3660	600	13.18



* The prices are without VAT

KITCHEN WORKTOPS H.P.L.

THICKNESS 30MM		ONE SIDE CURVED	TWO SIDES CURVED
CODE	WIDTH		
ZODIA :585-1090-812-457-551-406-373-313-278-924-972-1619-1661-1609-1643-9834,	40		17.03
	60	12.33	
	64		21.40
	80		25.75
LUCIDA : 585-924-931-972	40		17.96
	60	12.33	
	64		22.67
	80		27.01

KITCHEN WORKTOPS H.P.L. ONE SIDE CURVED WATER RESIST

WIDTH 60MM		FORM L	FORM U
CODE	THICKNESS		
ZODIA :585 - 1090 - 972 - 924	30	13.84	
	40		15.54
LUCIDA : 585	30	13.84	
	40		15.54

DUROPAL H.P.L. KITCHEN WORKTOP (FORM L)

THICKNESS 30MM		ONE SIDE CURVED	TWO SIDES CURVED
CODE	WIDTH		
ZODIA :R6390 - F7203 - R6213 - F7484 - F8194 - R6487 - R6254 - R6442 - R6480 -	40		23.75
	60	16.96	
	64		30.50
	80		37.13

DUROPAL H.P.L. KITCHEN WORKTOP (FORM U)

CODE	THICKNESS	PLAIN	WATER RESIST
ZODIA :R6390 - F7203 - R6213 - F7484 - F8194 - R6487 - R6254 - R6442 - R6480 - F8190	40	17.71	19.25

*The prices are without VAT

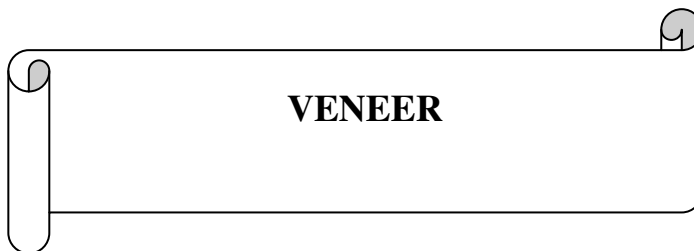

VENEER BEECH

QUALITY LENGTH		EURO/SQ.M.			
		Extra	A	B	C
800-1800		1.02	0.77	0.51	0.41
2100-2500		2.05	1.53	1.02	0.51
2550-3000		2.30	1.79	1.28	0.77

* The prices are without VAT

VENEER OAK/ASH

QUALITY LENGTH		EURO/SQ.M.			
		Extra	A	B	C
800-1800		1.53	1.12	0.77	0.61
2100-2500		2.45	1.94	1.53	0.77
2550-3000		2.66	1.36	1.79	0.77

* The prices are without VAT

Note:

- 1.The prices are for sales according to production to "Alfa Wood Bulgaria"S.A.
(The palets are mixed - dos, radial and half-radial bundles).
2. The clients can choose length and width, but it will be costs more.